

MANISCOPIC

MT 1033
HLT





- Maximum lifting height : 9.61 m
- Capacity : 3300 kg
- Maximum forward reach : 7.06 m
- Hydrostatic transmission
- 4 wheel drive
- Frame levelling

 **MANITOU**

MT 1033 HLT

 **Lifting capacity**3300 kg
at 500 mm from forks heels.
Tipping load at maximum reach740 kg
Tear out force with toothed digging bucket
to ISO 8313-1986 with tilting ram.....6600 daN

 **Lifting height** :9.61 m
Times : unladen/loaded (in s)
Lifting6.7/7.3
Lowering5/4.7
Simultaneous extension 1st and 2nd booms ...13.6/14.8
Simultaneous retraction 1st and 2nd booms.....8.1/7.8
Time unladen (in s)
Crowding3
Dumping2.5

 **Tyres**
400/80 - 24

 **Forks** (mm)
Length.....1200
Width x thickness.....125 X 45
Maximum distance outside forks1040
Carriage rotation.....126°

 **Brakes hydraulically operated
with oil-immersed multidiscs**

 **PERKINS Engine**
Type1104.C 44 Turbo
Capacity4 cylindres/4400 cm³
Power (ISO TR 14396)101 HP/74.5 kw
Maximum torque (ISO TR 14396) ...412 Nm at 1400 rpm
Direct Injection
Water Cooling

 **Transmission**hydrostatic
Electro-hydraulic reversing shift
Speeds forward and reverse4/2
Maximum travel speed.....25 km/h

 **Hydraulics**
Pump gear type.....250 bars/105 l/mn
Flow divider with priority to steering

 **Capacities**
Cooling system.....21 l.
Engine oil11 l.
Hydraulic oil128 l.
Fuel tank120 l.

 **Weight unladen** (with forks)7845 kg
Overall width2.26 m
Overall height2.30 m
Turning radius (outside wheels)3.89 m
Overall length4.96 m
Ground clearance0.44 m
Drawbar pull (loaded)8300 daN

Reach at maximum height : 2.73 m

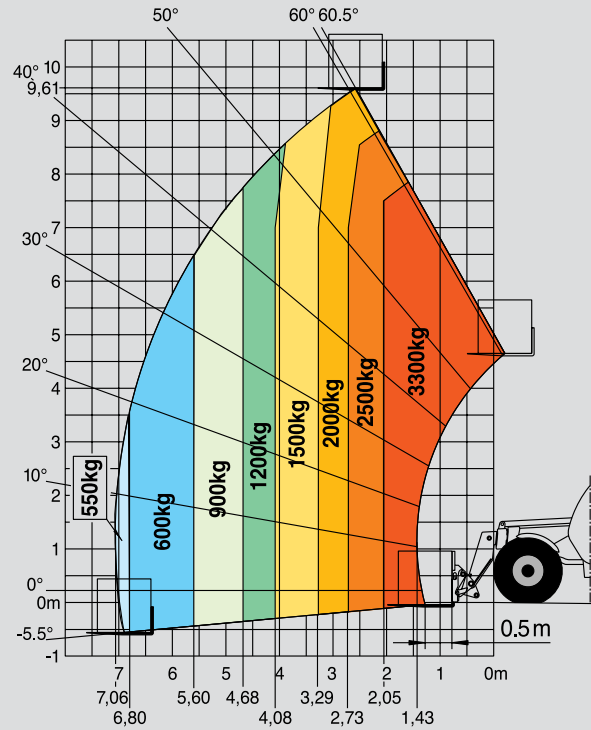

Under
EN 1459
annexe B

A	1200
B	2810
C	1395
C1	1482
D	4965
D1	5055
D2	4158
E	6165
F	1846
F1	1846
G	455
G1	440
G2	440
H	10°
H1	10°
I	763
J	865
K	1040
L	45
N	1690
O	125
P2	38°
P3	53°
R	3610
S	7815
T	3565
U1	2300
U2	2550
V	4925
V1	1360
V2	3818
W	2260
Y	11.9°
Z	113.7°

mm

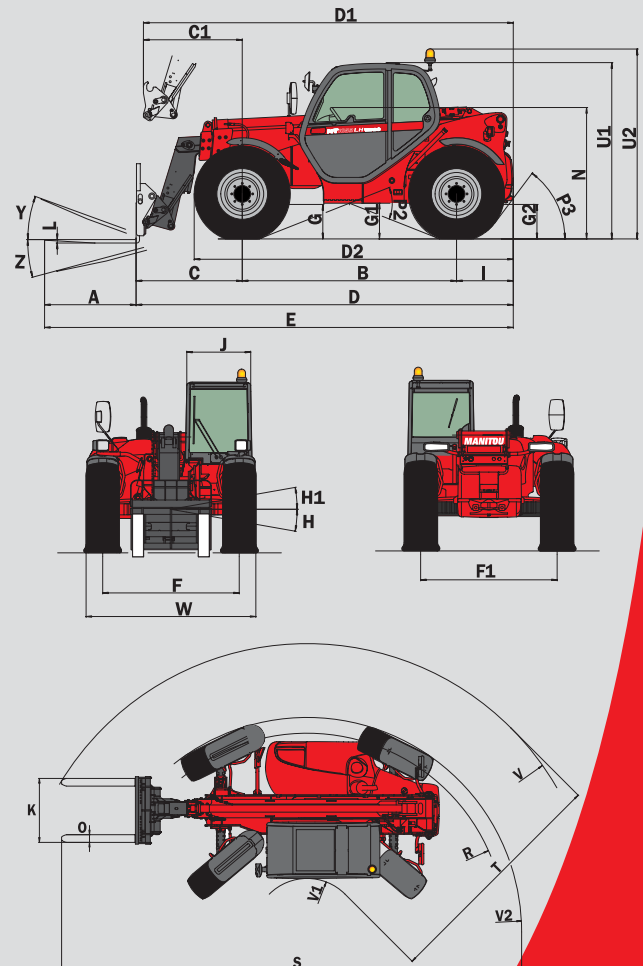

This publication in no way constitutes an offer and the company reserves the right to alter specification without prior notice.
The MANITOU models presented in this brochure can be supplied complete with optional equipment attachments.
PATENTS FR 93 14367 - EP 0 656 315 US PENDING



MANITOU BF SA
B.P. 249 - 44158 Ancenis Cedex - France
Tél. : 33 2 40 09 10 11 / Export Department Fax : 33 2 40 09 10 97
www.manitou.com

700023EN

